

SERVICE MANUAL

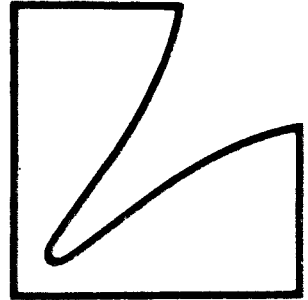

M-05

TWIN MONOLITHIC PURE CLASS "A"
POWER AMPLIFIER

M-05

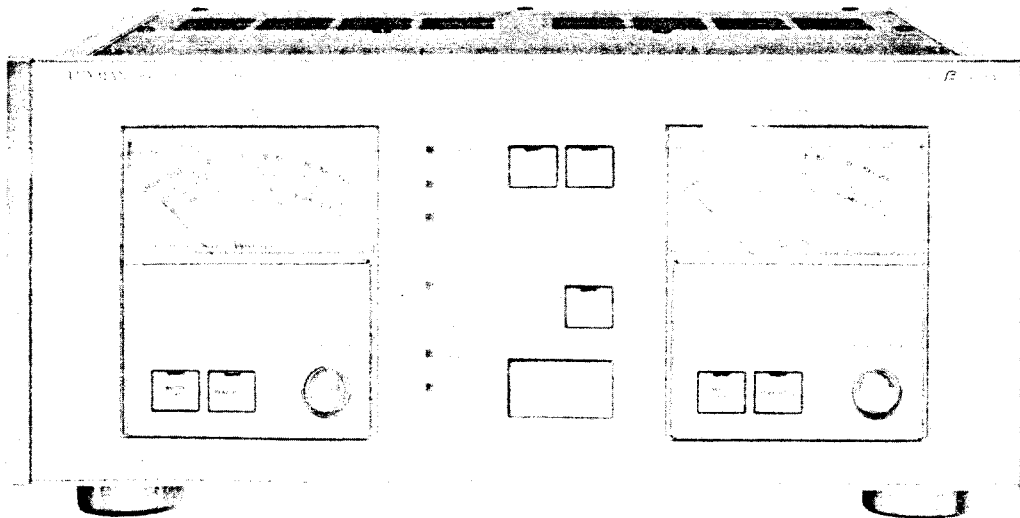

Contents

Destinations Parts List	1
Block Diagrams	2
Adjustment Locations	3
Adjustment Procedures	4
調整手順書	5
Exploded View	6
Exploded View Parts List	7-10
Packing Material Parts List	11
BTL SW PCB	12
Direct SW PCB	12
Main Amp PCB	12
Power PCB L/R	12
Pre Heat SW PCB	12
Signal & Subsonic PCB	12
LED PCB	12
Meter Drive PCB L/R	13
Peak Hold PCB L/R	13
LED PCB L/R	13
VR Control PCB L/R	13
Fan Speed SW PCB	13
BTL SW PCB Parts List	14
Direct SW PCB Parts List	14
Main Amp PCB L/R Parts List	14-15
Power PCB-L/R Parts List	15-17
Pre Heat SW PCB Parts List	17
Signal & Subsonic PCB Parts List	17
LED PCB Parts List	17
Meter Drive PCB L/R Parts List	17
Peak Hold PCB L/R Parts List	17
LED PCB L/R Parts List	17
VR Control PCB L/R Parts List	18
Fan Speed SW PCB Parts List	18
IC Handling Guide	19
Schematic Diagram (1)	20
Schematic Diagram (2)	21
Specifications	22
規 格	22

Destination's Parts List

Symbol No.	Description	J Japan 100V	SK Europe 220V-(240V)	UZ USA 120V
12	Holder, Fuse	09T51828F01	09T51074F01	09T51828F01
16	Cover, Rear	15D64791F01	15D64791F02	15D64791F03
20	Housing, Sensor	15B58781F01	None Use	None Use
21	Terminal, Sensor	29A58768F01	None Use	None Use
22	Lamp, Neon BNB-2-C	65T61618F01	None Use	None Use
24	Terminal	09T64474F01	Non Use	None Use
30	Plug, AC Cord	28T62216F01	28T65151F01	28T66838F01
31	Stopper, Cord	43B41625J05	43B41625J02	43B41625J02
75	Fuse	65T62175F01	65T42077U21	65T62175F01
76	Trans, Power	25T64489F01	25T64489F02	25T66827F01
99	Plate, Serial No.	64A63756F03	64A63756F04	64A63756F07
214	Screw, MCH. M3x15	03S52360F27	None Use	None Use
215	Washer, Spring M3	04S40071G20	None Use	None Use
216	Nut, Hexagon	02S40000G35	None Use	None Use
133	Spacer, Fuse	None Use	43A57047F02	None Use

Block Diagram

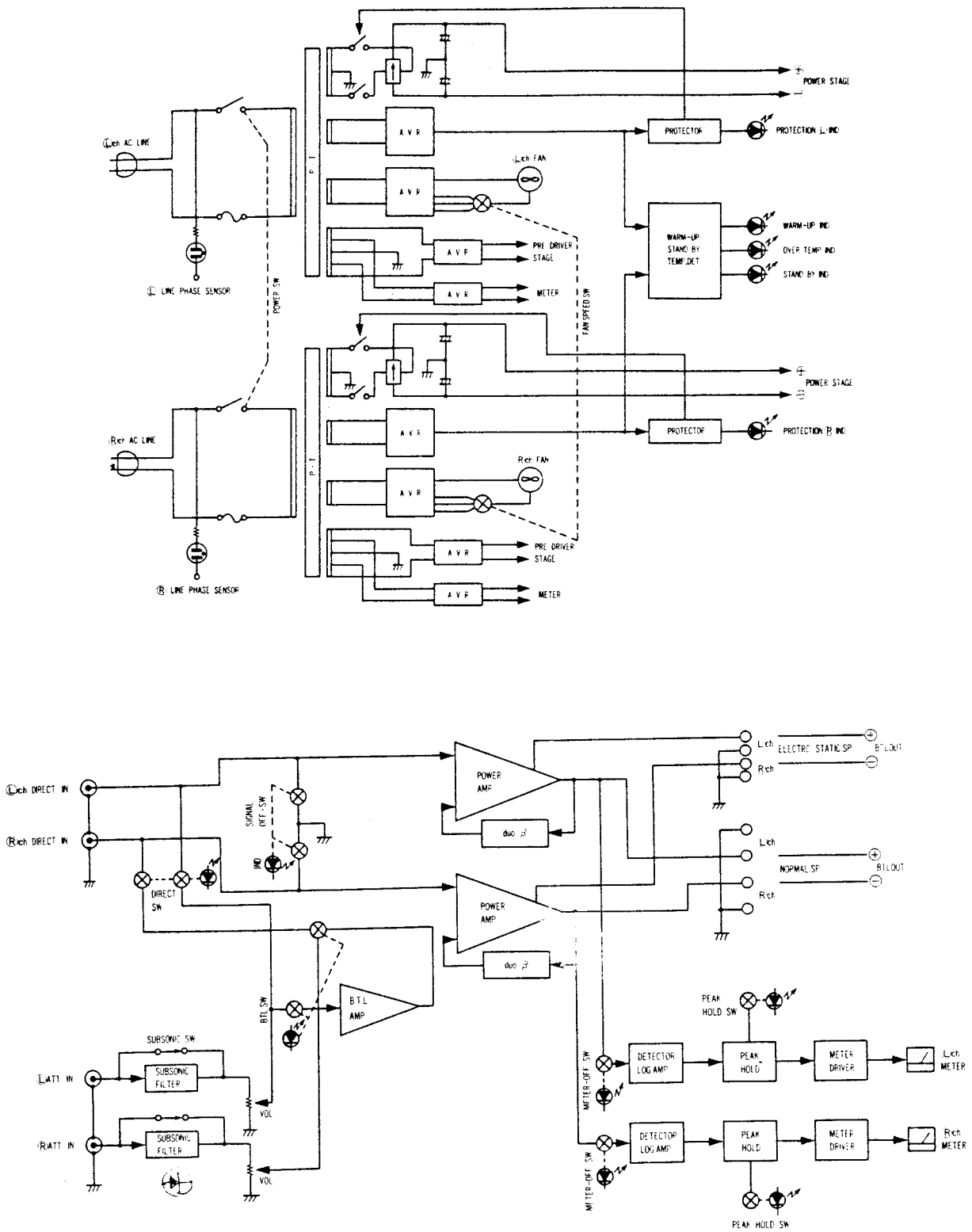

M-05

Adjustment Locations

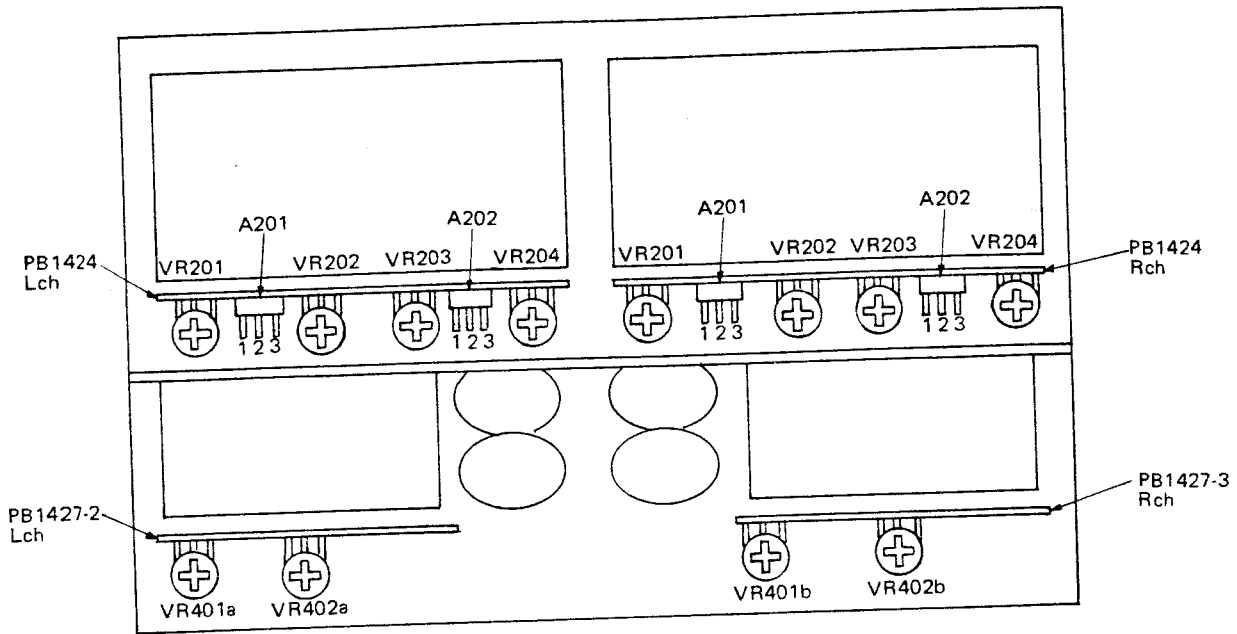

- VR201. . . . Idling Current Adjustment
- VR202. . . . DC Offset Adjustment
- VR203. . . . (-) Voltage Adjustment
- VR204. . . . (+) Voltage Adjustment
- VR401a, b. . . Meter Adjustment (-30dB)
- VR402a, b. . . Meter Adjustment (0dB)
- A201. . . . Terminal, Idling Check
- A202. . . . Terminal, Idling Check

Fig. 1

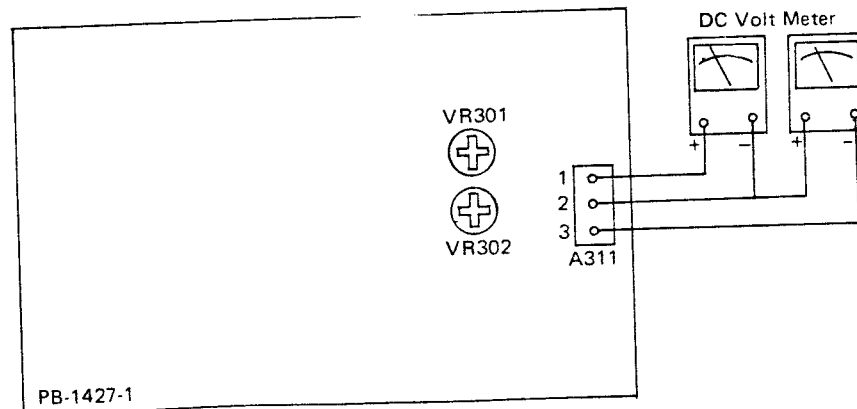

- VR301. . . . (+) Voltage Adjustment
- VR302. . . . (-) Voltage Adjustment

Fig. 2

Adjustment Procedures

1. Alignment of Idling Current
 - a. Remove the load, and connect a DC volt meter between the check terminals A201-1 and A201-2.
 - b. Turn on the power, and after 1 minute preadjust the VR201 to obtain 100mV on the volt meter.
 - c. Then after 4 minutes (5 minutes after the power is turned on), adjust the VR201 again to obtain 110mV.
2. Alignment of DC Offset
 - a. Connect a high sensitivity DC volt meter to the speaker terminal.
 - b. Adjust the VR202 so that the meter needle should show $0 \pm 5\text{mV}$.
3. Alignment of Regulator Voltage
 - a. Connect a DC volt meter between the check terminals A202-1 and A202-2, and then between the A202-2 and A202-3.
 - b. Adjust the VR203 to obtain $-56.2 \pm 0.1\text{V}$ between the A202-1 and A202-2.
 - c. Adjust the VR204 to obtain $+56.2 \pm 0.1\text{V}$ between the A202-2 and A202-3.
4. Alignment of BTL Amp Voltage (Fig. 2)
 - a. Remove the connector A311 on the PB1427-1.
 - b. Connect a DC volt meter between the terminals A311-1 and A311-2, and then between the A311-2 and A311-3.
 - c. Adjust the VR302 to obtain $-12\text{V} \pm 0.5\text{V}$ between the A311-1 and A311-2.
 - d. Adjust the VR301 to obtain $+12\text{V} \pm 0.5\text{V}$ between the A311-2 and A311-3.
5. Alignment of DC Offset on BTL Connection
 - a. Set the BTL selector switch to the "ON" position (upper side) and the input selector switch to the "Att-In" position (lower side). Also put the input attenuator at the endmost counter-clockwise position (no input is available).
 - b. Connect a high sensitivity DC volt meter to the "direct" input terminal of R-ch.
 - c. Adjust the VR101 to obtain the $0\text{V} + 5\text{mV}$ reading on the meter.
Attention : Before alignment, confirm that the BTL loads measuring instruments are not grounded to the M-05 itself.
6. Alignment of meters
 - a. Put on 8Ω load on the speaker terminal.
 - b. feed the 1KHz signal to the "Att-In" input, and adjust the power output at 100W (28.3V) with the volume at the max. position.
 - c. Adjust the VR402 to obtain the 0dB reading on the meter.
 - d. Reduce the output by 30dB.
 - e. Adjust the VR401 to obtain -30dB on the meter.
 - f. Repeat the steps b~e to obtain the accurate indications on both of the 0dB and -30dB output levels.

Exploded View

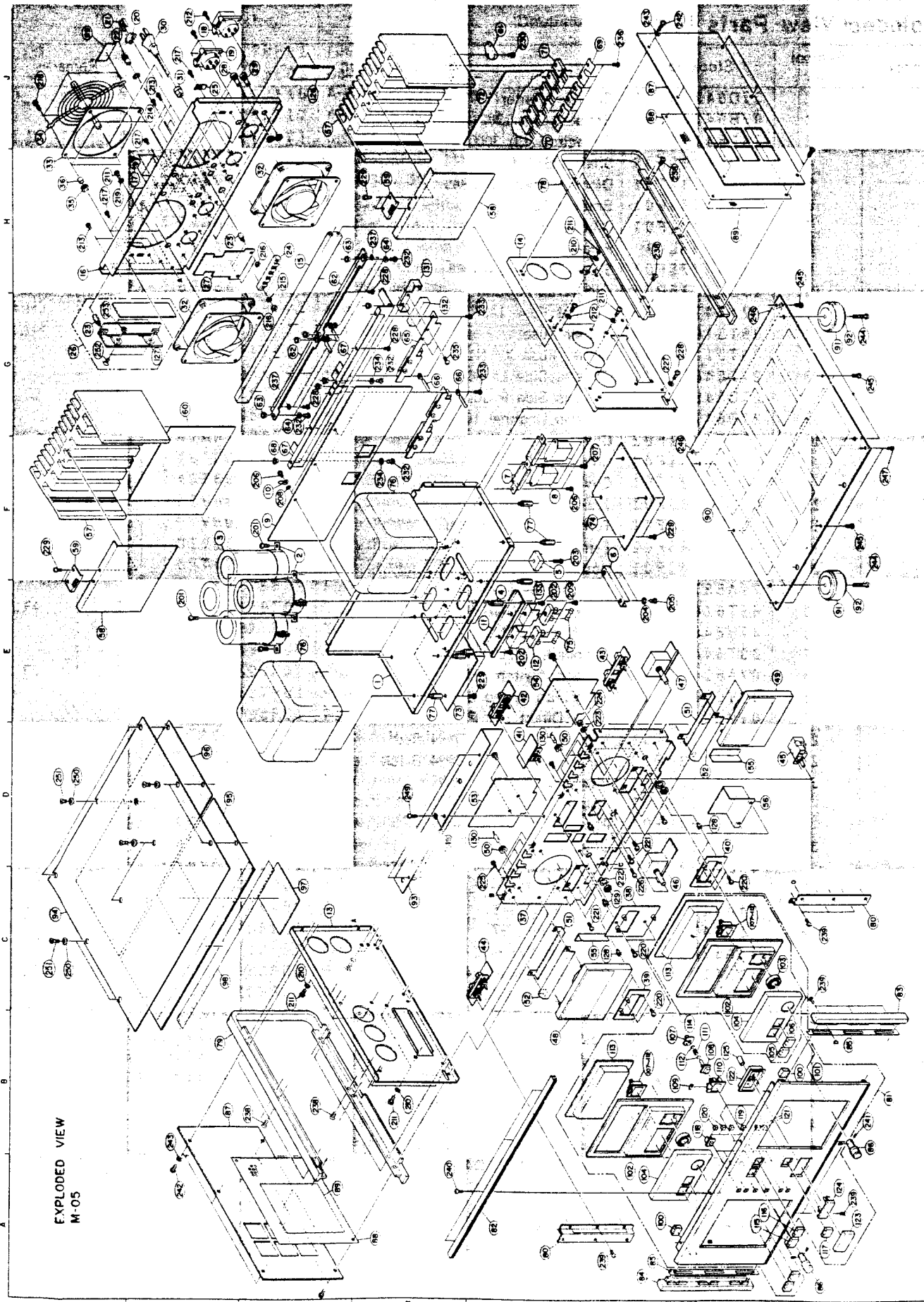

EXPLODED VIEW
M-05

M-05

Exploded View Parts List

Index	Symbol No.	Stock No.	Description	Remarks
E4	1	27D64773F01	Chassis, Center 1072	
F3	2	07B64776F01	Bracket, Cap 1302	
F2	3	23T64478F01	Capacitor (EI) 30000uF 56V	
E5	4	47B64899F30	Shaft, US1034	
F5	5	48T64237F01	Diode, Bridge S15VB40	
F6	6	07A64778F01	Bracket, 1398	
F5	7	07A64781F01	Bracket, 1405	
F5	8	80T0006L01	Relay, MAT2F	
F3	9	14C64775F01	Shield, Center 1444	
F3	10	29C41045P03	Lug, Wrap Around	
E5	11	07A64796F01	Bracket, Fuse 1407	
E5	12	09T51074F01	Holder, Fuse	SK
		09T51828F01	Holder, Fuse X-N1157	J, SK
C3	13	27D64808F01	Chassis, Side L 1060-1	
H5	14	27D64808F02	Chassis, Side R 1060-2	
H3	15	27D64774F01	Chassis, Channel 1051	
H2	16	15D64791F02	Cover, Rear 1226-2	SK
		15D64791F03	Cover, Rear 1226-3	UZ
		15D64791F01	Cover, Rear 1226-1	J
H2	17	09T64483F01	Jack, Pin 1P	
J2	18	09T64485F01	Terminal, Speaker Red	
J2	19	09T64485F02	Terminal, Speaker White	
J2	20	15B58781F01	Housing, Sensor	J
J1	21	29A58768F01	Terminal, Sensor	J
J1	22	65T61618F01	Lamp, Neon BNB-2-C	J
G1, H2	23	47B64899F33	Shaft, US 1069	
H3	24	09T64474F01	Terminal, F137D-1648-7P	J
J2	25	07A61439F01	Support, Switch 1248	
G1	26	01V66100F12	Ass'y, Fan Speed SW PCB	
H2	27	01V66100F10	Ass'y, Direct SW PCB	
J2	28	09T64484F01	Terminal, Speaker TJ-4 Red	
J3	29	09T64484F02	Terminal, Speaker TJ-4 Black	
J2	30	28T65151F01	Plug, AC Cord BK0062	SK
		28T66838F01	Plug, AC Cord	UZ
		28T62216F01	Plug, Cord BK0048	J
J2	31	43B41625J02	Stopper, Cord	SK, UZ
		43B41625J05	Stopper, Cord	J
G2, H3	32	59T64480F01	Fan, WS-2107-FL1009	
H1	33	64A64793F01	Panel, Fan 1442	
J1	34	15A64794F01	Cover, Fan 1397	
H1	35	43A62016F01	Bushing, 1077-UZ	
H1	36	43B41289U11	Sleeve, Cushion 4x4	
C5	37	27D64766F01	Chassis, Front 1083	
C6	38	01V66100F06	Ass'y, LED PCB	
C6	39	01V66100F07	Ass'y, LED PCB-L	
D7	40	01V66100F08	Ass'y, LED PCB-R	
D5	41	01V66100F23	Ass'y, Pre Heat SW PCB	
E5	42	01V66100F22	Ass'y, Sig & Subsonic PCB	
E6	43	01V66100F19	Ass'y, Peak Hold PCB-R	
C5	44	01V66100F18	Ass'y, Peak Hold PCB-L	
D7	45	40T57580F02	Switch, Push SDDA 3P	
C6	46	01V66100F20	Ass'y, VR Cont PCB-L	
E6	47	01V66100F21	Ass'y, VR Cont CB-R	
B5	48	72T64476F01	Meter, KPM-3G-L	
E7	49	72T64476F02	Meter, KPM-3G-R	
D5	50	43A62016F02	Bushing, UB1077-2	

Index	Symbol No.	Stock No.	Description	Remarks
C5, E6	51	61A64770F01	Filter, Lamp 1013	
C5, D7	52	15A64769F01	Cover, Lamp 1010	
D5	53	01V66100F16	Ass'y, Meter/D PCB-L	
E5	54	01V66100F17	Ass'y, Meter/D PCB-R	
C6, D7	55	14A64771F01	Insulator, 1032	
D7	56	07A64772F01	Bracket, Shield 1140	
F1, J3	57	07C64782F01	Heat Sink, 1097-1	
E1, H5	58	14B64783F01	Shield, Heat Sink	
F1, H4	59	07A64783F01	Bracket, 1406	
G2	60	01V66100F02	Ass'y, Main Amp PCB-L	
J5	61	40T64496F01	Terminal, GND OHD-110B	
G3, H3	62	07B64785F01	Bracket, 1404	
G3, H3	63	43A61755F02	Bushing, 0130-2	
G3, H4	64	04A65640F01	Washer, Fiber	
G4	65	07A64787F01	Bracket, 1410	
G4	66	29C41045P03	Lug, Wrap Around	
F3, G3	67	07B64788F01	Bracket, 1403	
F3	68	43A61755F02	Bushing, 0130-2	
J6	69	41A64790F01	Spring, TR 1408	
J5	70	48T60534F01	Transistor, 2SA1302 R, O	
J5	71	48T60533F01	Transistor, 2SC3281 R, O	
J5	72	01V66100F04	Ass'y, Main Amp PCB-R	
E4	73	01V66100F14	Ass'y, Power PCB-L	
F6	74	01V66100F15	Ass'y, Power PCB-R	
E5	75	65T42077U21	Fuse, Semko T3.15A	SK
		65T62175F01	Fuse, UL 7A-125V	J, UZ
E3, F4	76	25T64489F02	Trans, Power T3.15A	SK
		25T66827F01	Trans, Power	UZ
		25T64489F01	Trans, Power P-2636-J	J
E4, F5	77	47B64899F32	Shaft, US 5004	
H5	78	64C64797F01	Panel, Frame R 1045	
B2	79	64C64798F01	Panel, Frame L 1044	
A5, C8	80	07A64799F01	Bracket, Panel Side 1411	
B8	81	01V66100F33	Ass'y, Front Panel	
A5	82	64C64801F01	Panel, Front Top 1275	
C8	83	64B64802F01	Panel, Side L 1047	
A6	84	64B64803F01	Panel, Side L 1046	
A6, B8	85	43B64804F01	Spacer, Panel Side	
A8, B8	86	36A64805F01	Knob, Control 1160	
B2, J6	87	64D64763F01	Panel, Side 1048	
A4, J6	88	15B64764F01	Cover, Side 1048	
A3, H7	89	14A64765F01	Insulator, 1447	
F7	90	15D64762F01	Cover, Bottom 1125	
E8, G8	91	75A53282F01	Pad, Trannleg	
E8, G8	92	36A63759F01	Cap, Trannleg 1033	
C4	93	07B64806F01	Bracket, Cover 1110	
C1	94	64C64758F01	Panel, Top Cover 1238	
D2	95	26B64759F01	Shield, Top 1139	
D2	96	15B64760F01	Cover, 1047	
C3	97	26B64761F01	Shield, Top 1446	
C2	98	14S53018F68	Insulator, 1418	
J1	99	64A63756F04	Plate, Serial No.	SK
		64A63756F07	Plate, Serial No.	UZ
		64A63756F03	Plate, Serial No.	J
A6, B7	100	75A57803F08	Cushion, 10x20	
B8	101	64D64746F01	Panel, Front	
A6, C7	102	13D64754F01	Escutcheon, Meter 1169	
C7	103	13A64755F01	Escutcheon, VR 1176	

M-05

Index	Symbol No.	Stock No.	Description	Remarks
A6, B7	104	64B64756F01	Panel, Meter 1272	
B7	105	36B63733F14	Knob, Push Meter	
B7	106	36B63733F15	Knob, Push Peak	
B6	107	07B63737F01	Frame, Knob Push 1201	
B6, B7	108	07B63744F01	Frame, Knob Holder	
B6	109	61A63754F01	Crystal, Indicator 1125	
B6, B7	110	13A63742F01	Escutcheon, S 1165	
B6, B7	111	41A63752F01	Spring, 1051	
112	112	43A63753F01	Bushing, Spring 1058	
B6, C6	113	61A64757F01	Crystal, Meter 1127	
B6	114	01V66100F34	Ass'y, Meter Escutcheon 1169	
A7	115	36B63733F11	Knob, Push Subsonic	
A7	116	36B63733F12	Knob, Push Signal	
A8	117	36B63733F13	Knob, Push Stand—by	
B7	118	61A61446F01	Crystal, Indicator 1126	
B7	119	48T60388F03	LED, LD—101 YY	
37	120	48T60388F04	LED, LD101UR Red	
B7	121	48T60388F01	LED, LD101MG	
B7	122	13C64747F01	Escutcheon, Power	
A8	123	36B64748F01	Knob, Push Power	
A8	124	07C64749F01	Frame, Knob Power	
B8	125	43A64753F01	Spacer, Knob 1452	
J3	126	01V66100F09	Ass'y, BTL SW PCB	
G2	127	07A65156F01	Heat Sink, 1098	
C6, D7	128	47B64899F22	Shaft, US1042	
C6	129	47B64899F31	Shaft, US1050	
D5	130	65T64486F01	Lamp, Pilot 12V 75mA	
H4	131	07A64789F01	Bracket 1130	
G4	132	06T64482F01	Resistor, Cement 100 20W	
E5	133	43A57047F02	Spacer, Fuse	SK
E2, F3	201	03S40012G95	Screw, Tapping M4x8 Black	
E5	202	03S43997P76	Screw, MCH M4x8 Black Bind	
F5	203	03S63857F07	Screw, Tapping M4x16 Bind	
E6	204	04S40071G21	Washer, Spring M5	
E6	205	03S52360F55	Screw, MCH M5x8	
F3, F5	206	03S40012G96	Screw, Tapping M3x6 Bind	
F6	207	03S43997P76	Screw, MCH M3x6 Black Bind	
F3	208	04S40072G20	Washer, Tooth Lock M3	
E5	209	03S63857F08	Screw, Tapping M3x10 Pan—B	
B4, C3	210	04S40072G15	Washer, Tooth Lock B	
B4, C3	211	03S60012G95	Screw, Tapping M4x8 Black	
G6, J2	212	03S40012G93	Screw, Tapping M3x8	
H1, J2	213	03S43997P76	Screw, MCH M3x6 Black Bind	
J2	214	03S52360F27	Screw, MCH M3x15 Bind	J
H3	215	04S40071G20	Washer, Spring M3	J
G3, H3	216	02S40000G35	Nut, Hex M3	J
H1, J2	217	03S43997P83	Screw, MCH M2.6x4	
J1	218	03S63857F09	Screw, Tapping M4x20 Bind	
H1	219	04S40072G15	Washer, Tooth Lock B	
C6, C7	220	03C40014G48	Screw, MCH M3x4 Bind	
C6, D6	221	03C40014G50	Screw, MCH M3x6 Bind	
C6	222	04S40072G22	Washer, Tooth Lock M8 Black	
E6	223	04S40071G11	Washer, 3.1x5.9x0.7	
E6	224	02S40000G35	Nut, Hex M3	
C5	225	03S43997P76	Screw, MCH M3x6 Black Bind	
C6	226	03S40012G96	Screw, Tapping M3x6 Bind	
G6	227	04S40072G15	Washer, Tooth Lock B	
G3, G4	228	03S40012G95	Screw, Tapping M4x8 Black	

Index	Symbol No.	Stock No.	Description	Remarks
E5, F1	229	03S43997P76	Screw, MCH M3x6 Black Bind	
J5	230	03C40014G49	Screw, MCH M3x8 Black	
J5	231	03S40011G93	Screw, MCH M3x8	
F4, G3	232	03S52360F36	Screw, MCH M4x8 Bind	
G5	233	03S40012G96	Screw, Tapping M3x6 Bind	
F4, G4	234	04A65640F01	Washer, Fiber	
G4	235	03S52360F42	Screw, MCH M3x4 Bind	
J6	236	03S52360F43	Screw, MCH M3x15 SUS	
G3, H4	237	04S40072G15	Washer, Tooth Lock B	
A8, B3	238	03S63857F12	Screw, Tapping M4x8 Flat-B	
A6, C8	239	03S40012G93	Screw, Tapping M3x8	
A4	240	03S40012G98	Screw, Tapping M3x8 Flat	
B8	241	03A40015G02	Screw, Set M3	
A2, J6	242	03S63857F10	Screw, Tapping M4x12 Bind	
B2, J6	243	04S40070G59	Washer, Flat 06 Black	
F8, G8	244	03S63857F03	Screw, Tapping M4x25 Bind	
F8, G8	245	03S40012G95	Screw, Tapping M4x8 Black	
F6, G7	246	04S40072G15	Washer, Tooth Lock B	
F8	247	03S63857F01	Screw, Tapping M4x10 Bind	
D4	248	04S40072G20	Washer, Tooth Lock M3	
D4	249	03S40012G96	Screw, Tapping M3x6 Bind	
C1, D1	250	04A63757F01	Washer, Special 1240	
C1, D1	251	03S63857F17	Screw, Tapping M4x8 Oval	
G1	252	03S52360F57	Screw, MCH M3x12 Flat	
G1	253	02B47353F02	Nut, Hex Flange M3	

M-05

PCB

BTL SW PCB

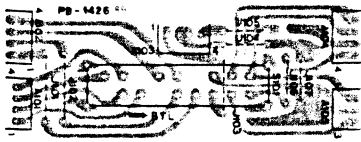

Main Amp PCB L/R

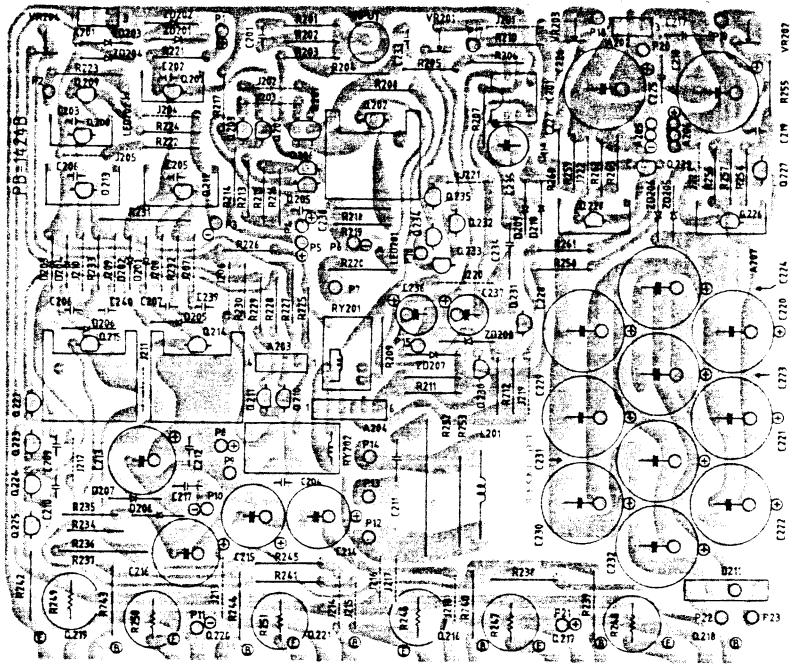

Direct SW PCB

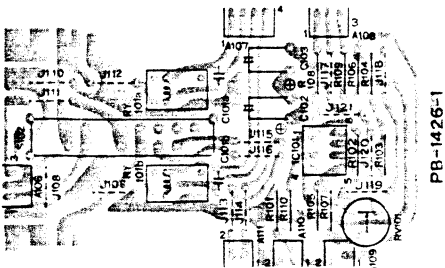

Power PCB L

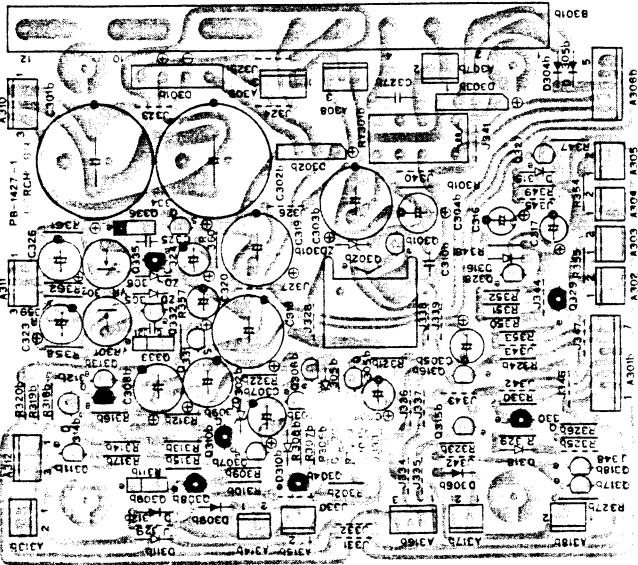

Power PCB R

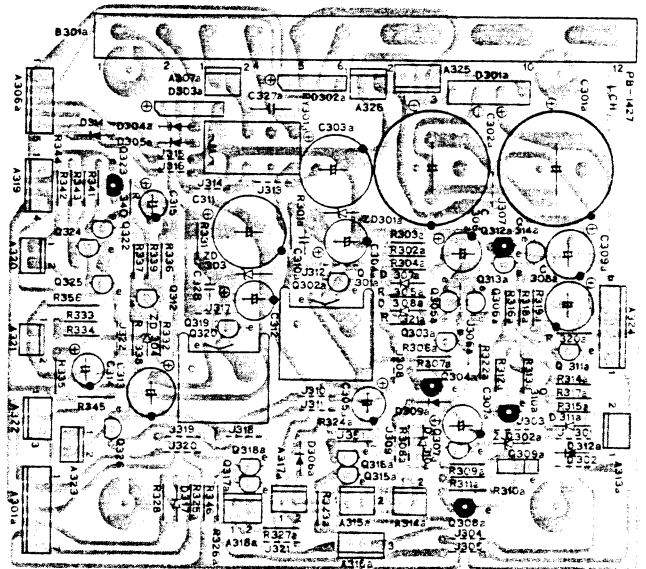

Pre Heat SW PCB

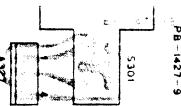

Signal & Susonic PCB

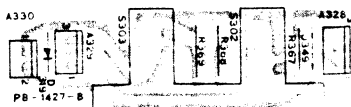

LED PCB

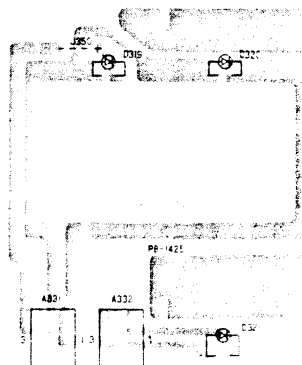

M-05

Meter Drive PCB L

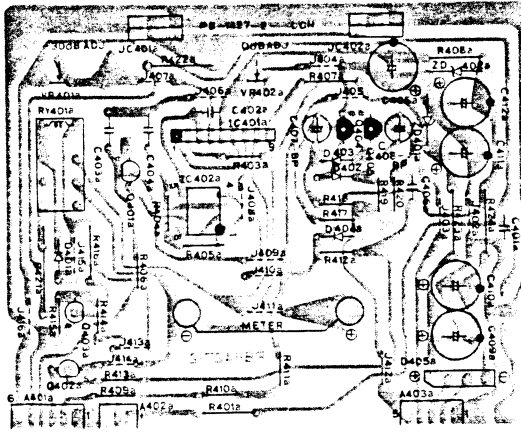

Meter Drive PCB R

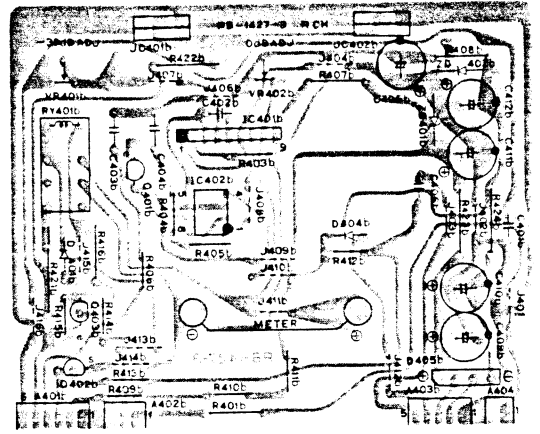

Peak Hold PCB L

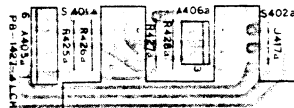

Peak Hold PCB R

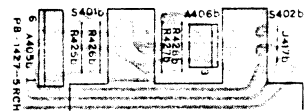

LED PCB L

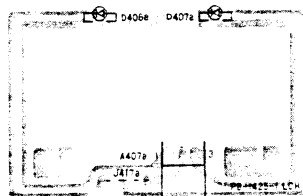

LED PCB R

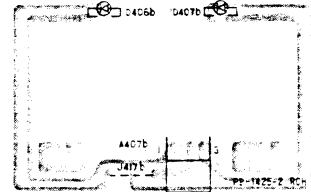

VR Control PCB L

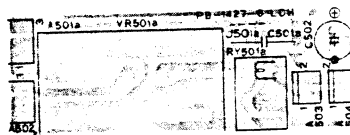

VR Control PCB R

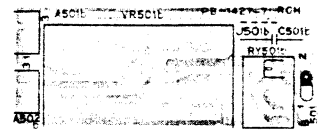

Fan Speed SW PCB

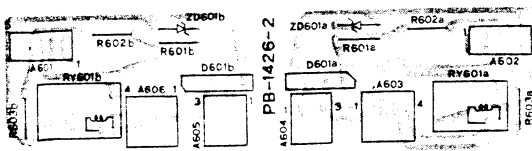

Fan Speed SW PCB

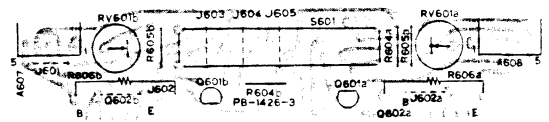

BTL SW PCB Parts List

Symbol No.	Stock No.	Description
(Switch)		
S101	40T64490F01	Slide SSB06270-S

Direct SW PCB Parts List

Symbol No.	Stock No.	Description
(Relay)		
RY101a,b	80T00049L01	SZ-12W
(Switch)		
S102	40T64490F01	Slide, SSB06270-S
(Variable Resistor)		
RV101	18C41732G09	47K
(IC)		
IC101	51T62647F01	NJM082D
(Capacitor)		
C102	23T00029L45	(EI) 100uF 16V
C103	23T00029L45	(EI) 100uF 16V
(Resistor)		
R101	06T00051L36	(Rd) 820KΩ 1/4W
R102	06T00050L89	(Rd) 10KΩ 1/4W
R103	06T00050L89	(Rd) 10KΩ 1/4W
R104	06T00050L41	(Rd) 100Ω 1/4W
R105	06T00050L81	(Rd) 4.7KΩ 1/4W
R106	06T00051L36	(Rd) 820KΩ 1/4W
R107	06T00050L97	(Rd) 22KΩ 1/4W
R108	06T00032L41	(Rf) 100Ω 1/2W
R109	06T00032L41	(Rf) 100Ω 1/2W
R110	06T00050L65	(Rd) 1KΩ 1/4W

Main Amp PCB L/R Parts List

Symbol No.	Stock No.	Description
(Jack)		
INPut	09T64488F01	Pin 1P YJ-206AU
(Relay)		
RY201	80T00049L01	MZ-12W
RY202	80T80048L01	RZ-12W
(Variable Resistor)		
VR201	18T61417F04	1K
VR202	18T61417F06	2.2KB
VR203	18T61417F06	2.2KB
VR204	18T43733P10	1.0K-1/2W
(Coil)		
L201	24T64487F01	LA1199U
(IC)		
IC201	51T62647F01	NJM082D
(Transistor & FET)		
Q201	48T52146F03	2SK146 V
Q202	48T60531F01	2SC2704 O,Y
Q203	48T56658F01	2SC1904 B,V
Q204	48T56658F01	2SC1904 B,V
Q205	48T60751F01	2SA1145 O,Y
Q206	48T60751F01	2SA1145 O,Y
Q207	48T60532F01	2SA1144 O,Y
Q208	48T60531F01	2SC2704 O,Y
Q209	48T60752F01	2SC2705 O,Y

Symbol No.	Stock No.	Description
Q210	48T60752F01	2SC2705 O,Y
Q211	48T60751F01	2SA1145 O,Y
Q212	48T60531F01	2SC2704 O,Y
Q213	48T60532F01	2SA1144 O,Y
Q214	48T62642F01	2SC2336
Q215	48T62641F01	2SA1006
Q222	48T51121F01	2SA992
Q223	48T56662F01	2SC1845 E,F
Q224	48T56662F01	2SC1845 E,F
Q225	48T51121F01	2SA992
Q226	48T62648F01	2SC1624 O,Y
Q227	48T60752F01	2SC2705 O,Y
Q228	48T62644F01	2SA814 O,Y
Q229	48T60751F01	2SA1145 O,Y
Q230	48S43525F05	2SC1815-Y,GR
Q231	48T51118F01	2SA1015-Y
Q232	48T51539F01	2SK117 (Y)
Q233	48T52545F01	2SA970 BL
Q234	48T53301F01	2SC2240 BL
Q235	48T51539F01	2SK117 (Y)
Q235	48T56658F01	2SC1904 B,V
(Diode)		
D205	48T51117F01	1S1553
D206	48T51117F01	1S1553
D207	48T51117F01	1S1553
D208	48T51117F01	1S1553
D209	48T51117F01	1S1553
D210	48T51117F01	1S1553
D211	48T62282F01	UB152
(Diode,Zener)		
ZD201	48T64467F48	BZ-240
ZD202	48T64467F48	BZ-240
ZD203	48T64467F48	BZ-240
ZD204	48T64467F48	BZ-240
ZD205	48T64467F35	BZ-150
ZD206	48T64467F35	BZ-150
ZD207	48T64467F35	BZ-150
ZD208	48T64467F35	BZ-150
(LED)		
LED201	48T62493F01	AA3422K-U
LED202	48T62493F01	AA3422K-U
(Capacitor)		
C201	08T42081U01	(Pp) 100pF
C202	08T63315F02	(Mi) 2uF
C203	08T63315F02	(Mi) 2uF
C204	08T42081U11	(Pp) 270pF
C211	08T64540F01	() 0.027uF
C213	23T43197F97	(EI) 47uF 100V
C214	23T43197F97	(EI) 47uF 100V
C215	23T43197F97	(EI) 47uF 100V
C216	23T43197F97	(EI) 47uF 100V
C217	08T61407F01	(Ac) 0.22uF 125V
C218	23T00024L09	(EI) 220uF 100V
C220	23T00024L09	(EI) 220uF 100V
C221	23T00024L09	(EI) 220uF 100V
C222	23T00024L09	(EI) 220uF 100V
C223	23T00024L09	(EI) 220uF 100V
C224	23T00024L09	(EI) 220uF 100V

Symbol No.	Stock No.	Description
C225	08T61407F01	(Ac) 0.22uF 125V
C226	22T00024L09	(Ac) 220uF 125V
C228	23T00024L09	(EI) 220uF 100V
C229	23T00024L09	(EI) 220uF 100V
C230	23T00024L09	(EI) 220uF 100V
C231	23T00024L09	(EI) 220uF 100V
C232	23T00024L09	(EI) 220uF 100V
C234	08T00019L10	(Pe) 2.2uF
C235	23T61177F06	(EI) 4.7uF 100V BP
C236	23T43197F49	(EI) 47uF 25V
C237	23T43197F49	(EI) 47uF 25V

(Resistor)		
Symbol No.	Stock No.	Description
R201	06T00013L35	(Rd) 56Ω 1/3W
R202	06T00014L26	(Rd) 330KΩ 1/3W
R203	06T00013L53	(Rd) 330Ω 1/3W
R204	06T00013L40	(Rd) 91Ω 1/3W
R205	06T00014L08	(Rd) 56KΩ 1/3W
R206	06T00013L97	(Rd) 22KΩ 1/3W
R207	06T00013L85	(Rd) 6.8KΩ 1/3W
R208	06T00013L77	(Rd) 3.3KΩ 1/3W
R209	06T00014L12	(Rd) 82KΩ 1/3W
R211	06T00013L71	(Rd) 1.8KΩ 1/3W
R212	06T00013L71	(Rd) 1.8KΩ 1/3W
R213	06T00013L53	(Rd) 330Ω 1/3W
R214	06T00014L26	(Rd) 330KΩ 1/3W
R215	06T00013L53	(Rd) 330Ω 1/3W
R216	06T00013L53	(Rd) 330Ω 1/3W
R217	06T00014L06	(Rd) 47KΩ 1/3W
R218	06T00013L49	(Rd) 220Ω 1/3W
R219	06T00013L49	(Rd) 220Ω 1/3W
R220	06T00003L95	(Rd) 18KΩ 1/2W
R221	06T00013L73	(Rd) 2.2KΩ 1/3W
R222	06T00013L73	(Rd) 2.2KΩ 1/3W
R223	06T00003L95	(Rd) 18KΩ 1/2W
R224	06T00013L49	(Rd) 220Ω 1/3W
R225	06T00014L22	(Rd) 220KΩ 1/3W
R226	06T00014L22	(Rd) 220KΩ 1/3W
R227	06T00013L63	(Rd) 820Ω 1/3W
R228	06T00013L59	(Rd) 560Ω 1/3W
R229	06T00013L59	(Rd) 560Ω 1/3W
R230	06T00013L63	(Rd) 820Ω 1/3W
R231	06T00007L59	(Rm) 560Ω 2W
R232	06T00013L41	(Rd) 100Ω 1/3W
R233	06T00013L41	(Rd) 100Ω 1/3W
R234	06T00014L04	(Rd) 39KΩ 1/3W
R235	06T00014L04	(Rd) 39KΩ 1/3W
R236	06T00013L59	(Rd) 560Ω 1/3W
R237	06T00007L41	(Rm) 100Ω 2W
R238	06T00003L09	(Rd) 4.7Ω 1/2W
R239	06T00003L09	(Rd) 4.7Ω 1/2W
R240	06T00003L09	(Rd) 4.7Ω 1/2W
R241	06T00003L65	(Rd) 1KΩ 1/2W
R242	06T00003L65	(Rd) 1KΩ 1/2W
R243	06T00003L09	(Rd) 4.7Ω 1/2W
R244	06T00003L09	(Rd) 4.7Ω 1/2W
R245	06T00003L09	(Rd) 4.7Ω 1/2W
R246	06T64481F01	(Rc) 0.22Ω 5W
R247	06T64481F01	(Rc) 0.22Ω 5W

Symbol No.	Stock No.	Description
R248	06T64481F01	(Rc) 0.22Ω 5W
R249	06T64481F01	(Rc) 0.22Ω 5W
R250	06T64481F01	(Rc) 0.22Ω 5W
R251	06T64481F01	(Rc) 0.22Ω 5W
R252	06T00009L29	(Rm) 33Ω 1/3W
R253	06T00007L17	(Rm) 10Ω 2W
R254	06T00013L93	(Rd) 15KΩ 1/3W
R255	06T00013L81	(Rd) 4.7KΩ 1/3W
R256	06T00013L81	(Rd) 4.7KΩ 1/3W
R257	06T00004L12	(Rd) 33KΩ 1/3W
R259	06T00013L93	(Rd) 15KΩ 1/3W
R260	06T00013L81	(Rd) 4.7KΩ 1/3W
R262	06T00013L81	(Rd) 4.7KΩ 1/3W
R263	06T00014L02	(Rd) 33KΩ 1/3W
R264	06T00013L91	(Rd) 12KΩ 1/3W
R265	06T00013L91	(Rd) 12KΩ 1/3W

Power PCB L/R Parts List

Symbol No.	Stock No.	Description
(Terminal)		
B301a,b	09T64473F01	Block GSK801/12
(Relay)		
RY301a,b	80T00048L01	RZ-12W
(Variable Resistor)		
VR301	18C41732G03	4.7K-B
VR302	18C41732G03	4.7K-B
(Transistor & FET)		
Q301a,b	48S44578J01	2SC945L P
Q302a,b	48T42620F02	2SD880-Y
Q303a,b	48S44578J01	2SC945L P
Q304a,b	48T51119F01	2SA965
Q305a,b	48S44578J01	2SC945L P
Q306a,b	48S44578J01	2SC945L P
Q307a,b	48S44578J01	2SC945L P
Q308a,b	48T40081T03	2SA733 (P)
Q309a,b	48T56660F03	2SC2824 O, Y
Q310a,b	48T40081T03	2SA733 (P)
Q311a,b	48S44578J01	2SC945L P
Q312a,b	48T40081T03	2SA733 (P)
Q313a,b	48S44578J01	2SC945L P
Q314a,b	48S44578J01	2SC945L P
Q315a,b	48T45274F02	2SC2120 Y
Q316a,b	48S44578J01	2SC945L P
Q317a,b	48S44578J01	2SC945L P
Q318a,b	48S44578J01	2SC945L P
Q319	48S44578J01	2SC945L P
Q320	48T42620F02	2SD880-Y
Q322	48S44578J01	2SC945L P
Q323	48T40081T03	2SA733 (P)
Q324	48S44578J01	2SC945L P
Q325	48S44578J01	2SC945L P
Q326	48S44578J01	2SC945L P
Q327	48S44578J01	2SC945L P
Q328	48S44578J01	2SC945L P
Q329	48T40081T03	2SA733 (P)
Q330	48T40081T03	2SA733 (P)
Q331	48T51539F01	2SK117 (Y)

Symbol No.	Stock No.	Description
Q332	48S44578J01	2SC945L P
Q333	48T64434F01	2SC2824 O,Y
Q334	48T51539F01	2SK117 (Y)
Q335	48T40081T03	2SA733 (P)
Q336	48T64435F01	2SB549Q R
(Diode)		
D301a,b	48T62282F01	UB152
D302a,b	48T51116F01	S1VB10
D303a,b	48T51116F01	S1VB10
D304a,b	48T55186F01	GP10D -AX
D305a,b	48T55186F01	GP10D -AX
D306a,b	48T55186F01	GP10D -AX
D307a,b	48T61117F01	1S1553
D308a,b	48T61117F01	1S1553
D309a,b	48T55186F01	GP10D -AX
D310a,b	48T51117F01	1S1553
D311a,b	48T51117F01	1S1553
D312a,b	48T55186F01	GP10D -AX
D314	48T55186F01	GP10D -AX
D315	48T51117F01	1S1553
D316	48T51117F01	1S1553
D317	48T51117F01	1S1553
D318	48T51117F01	1S1553
(Diode,Zener)		
ZD302a,b	48T52739F41	HZ 6C-2 -AX
ZD303	48T52739F75	HZ12B-3 -AX
ZD304	48T52739F41	HZ 6C-2 -AX
ZD305	48T52739F13	HZ 3C-1 -AX
ZD306	48T52739F13	HZ 3C-1 -AX
ZD310a,b	48T52739F75	HZ12B-3 -AX
(Capacitor)		
C301a,b	23T64477F01	(Ei) 3300uF 25V
C302a,b	23T64477F01	(Ei) 3300uF 25V
C303a,b	23T00029L85	(Ei) 2200uF 25V
C304a,b	23T00030L44	(Ei) 100uF 16V
C305a,b	23T00030L44	(Ei) 100uF 16V
C306a,b	23T00030L36	(Ei) 47uF 6.3V
C307a,b	23T00030L44	(Ei) 100uF 16V
C308a,b	23T00029L53	(Ei) 220uF 16V
C309a,b	23T00029L53	(Ei) 220uF 16V
C310a,b	21S40655F23	(Ce) 100pF
C311	23T00029L78	(Ei) 1000uF 25V
C312	23T00030L44	(Ei) 100uF 16V
C313	23T00030L44	(Ei) 100uF 16V
C314	23T00030L47	(Ei) 220uF 10V
C315	23T00030L03	(Ei) 1.0uF 50V
C316	23T00030L17	(Ei) 10uF 25V
C317	23T00030L17	(Ei) 10uF 25V
C318	23T00029L78	(Ei) 1000uF 25V
C319	23T00029L78	(Ei) 1000uF 25V
C320	23T00030L37	(Ei) 47uF 10V
C321	08T61642F20	(Mi) 47pF 500V
C323	23T00030L44	(Ei) 100uF 16V
C324	23T00030L37	(Ei) 47uF 10V
C325	08T61642F20	(Mi) 47pF 500V
C326	23T00030L44	(Ei) 100uF 16V
C327a,b	08T57437F09	(Ac) 0.01uF
C328	21S40655F23	(Ce) 100pF

Symbol No.	Stock No.	Description
(Resistor)		
R301a,b	06T00059L53	(Rd) 330Ω 1/4W
R302a,b	06T00059L85	(Rd) 6.8KΩ 1/4W
R303a,b	06T00059L67	(Rd) 1.2KΩ 1/4W
R304a,b	06T00060L06	(Rd) 47KΩ 1/4W
R305a,b	06T00059L65	(Rd) 1KΩ 1/4W
R306a,b	06T00059L85	(Rd) 6.8KΩ 1/4W
R307a,b	06T00059L89	(Rd) 10KΩ 1/4W
R308a,b	06T00060L14	(Rd) 100KΩ 1/4W
R309a,b	06T00059L77	(Rd) 3.3KΩ 1/4W
R310a,b	06T00059L89	(Rd) 10KΩ 1/4W
R311a,b	06T00059L41	(Rd) 100Ω 1/4W
R312a,b	06T00059L89	(Rd) 10KΩ 1/4W
R313a,b	06T00059L89	(Rd) 10KΩ 1/4W
R314a,b	06T00059L89	(Rd) 10KΩ 1/4W
R315a,b	06T00059L89	(Rd) 10KΩ 1/4W
R316a,b	06T00059L89	(Rd) 10KΩ 1/4W
R317a,b	06T00059L89	(Rd) 10KΩ 1/4W
R318a,b	06T00059L93	(Rd) 10KΩ 1/4W
R319a,b	06T00059L79	(Rd) 3.9KΩ 1/4W
R320a,b	06T00060L06	(Rd) 47KΩ 1/4W
R321a,b	06T00059L97	(Rd) 22KΩ 1/4W
R322a,b	06T00059L97	(Rd) 22KΩ 1/4W
R323a,b	06T00059L89	(Rd) 10KΩ 1/4W
R324a,b	06T00059L89	(Rd) 10KΩ 1/4W
R325a,b	06T00059L97	(Rd) 22KΩ 1/4W
R326a,b	06T00059L97	(Rd) 22KΩ 1/4W
R327a,b	06T00017L59	(Rd) 560Ω 1/2W
R328	06T00059L89	(Rd) 10KΩ 1/4W
R329	06T00059L89	(Rd) 10KΩ 1/4W
R330	06T00059L75	(Rd) 2.7KΩ 1/4W
R331	06T00059L53	(Rd) 330Ω 1/4W
R332	06T00060L46	(Rd) 2.2MΩ 1/4W
R333	06T00060L54	(Rd) 4.7MΩ 1/4W
R334	06T00060L54	(Rd) 4.7MΩ 1/4W
R335	06T00060L50	(Rd) 3.3MΩ 1/4W
R336	06T00059L81	(Rd) 4.7KΩ 1/4W
R337	06T00059L73	(Rd) 2.2KΩ 1/4W
R338	06T00059L83	(Rd) 5.6KΩ 1/4W
R339	06T00059L89	(Rd) 10KΩ 1/4W
R340	06T00059L89	(Rd) 10KΩ 1/4W
R341	06T00059L97	(Rd) 22KΩ 1/4W
R342	06T00059L97	(Rd) 22KΩ 1/4W
R343	06T00059L89	(Rd) 10KΩ 1/4W
R344	06T00017L59	(Rd) 560Ω 1/2W
R345	06T00017L59	(Rd) 560Ω 1/2W
R346	06T00059L89	(Rd) 10KΩ 1/4W
R347	06T00059L65	(Rd) 1KΩ 1/4W
R348	06T00060L06	(Rd) 47KΩ 1/4W
R349	06T00060L06	(Rd) 47KΩ 1/4W
R350	06T00059L53	(Rd) 680Ω 1/4W
R351	06T00059L53	(Rd) 680Ω 1/4W
R352	06T00059L81	(Rd) 4.7KΩ 1/4W
R353	06T00060L06	(Rd) 47KΩ 1/4W
R354	06T00017L59	(Rd) 560Ω 1/2W
R355	06T00017L59	(Rd) 560Ω 1/2W
R356	06T00017L59	(Rd) 560Ω 1/2W
R357	06T00050L89	(Rd) 10KΩ 1/4W

Symbol No.	Stock No.	Description
R358	06T00059L85	(Rd) 6.8K Ω 1/4W
R359	06T00059L77	(Rd) 3.3K Ω 1/4W
R360	06T00059L69	(Rd) 1.5K Ω 1/4W
R361	06T00059L85	(Rd) 6.8K Ω 1/4W
R362	06T00059L77	(Rd) 3.3K Ω 1/4W

Pre Heat SW PCB Parts List

Symbol No.	Stock No.	Description
(Switch)		
S301	40T64494F01	Push SUN121S

Signal & Subsonic PCB Parts List

Symbol No.	Stock No.	Description
(Switch)		
S302-303	40T64493F01	Push SUN211A
(Diode)		
D319	48T55186F01	GP10D -AX
(Resistor)		
R367	06T00059L89	(Rd) 10K Ω 1/4W
R368	06T00017L59	(Rd) 560 Ω 1/2W

LED PCB Parts List

Symbol No.	Stock No.	Description
(LED)		
D319	48T63906F01	EAY3432S O.Y
D320	48T63906F01	EAY3432S O.Y
D321	48T63906F01	EAY3432S O.Y
(Resistor)		
R356	06T00017L59	(Rd) 560 Ω 1/2W

Meter Drive PCB L/R Parts List

Symbol No.	Stock No.	Description
(Relay)		
RY401a,b	80T00048L01	RZ-12W
(Variable Resistor)		
VR401a,b	18T61417F12	22KB
VR402a,b	18T61417F02	470
(IC)		
IC401a,b	51T41803U01	TA318AP-2
IC402a,b	51T62647F01	NJM082D
(Transistor & FET)		
Q401a,b	48T56662F01	2SC1845 E,F
Q402a,b	48T51539F01	2SK117 (Y)
Q403a,b	48S44578J01	2SC945L P
Q404	48T40081T03	2SA733 (P)
Q405	48T40081T03	2SA733 (P)
(Diode)		
D401a,b	48T51117F01	1S1553
D402a,b	48T51117F01	1S1553
D403a,b	48T51117F01	1S1553
D404a,b	48T51117F01	1S1553
D405a,b	48T51116F01	S1VB10
(Diode, Zener)		
ZD401a,b	48T40150U66	HZ12B 3

Symbol No.	Stock No.	Description
ZD402a,b	48T40150U66	HZ12B-3
(Capacitor)		
C402a,b	08S40656F01	(My) 1000pF
C403a,b	08S44503P29	(My) 0.22uF
C404a,b	08S44503P29	(My) 0.22uF
C405a,b	23T00029L53	(EI) 220uF 16V
C406a,b	08S40656F25	(My) 0.1uF
C407	23S41192U28	(EI) 10uF 16V BP
C408	23S41192U01	(EI) 0.47uF 50V BP
C409a,b	23T00029L70	(EI) 470uF 25V
C410a,b	23T00029L70	(EI) 470uF 25V
C411a,b	23T00029L53	(EI) 220uF 16V
C412a,b	23T00029L53	(EI) 220uF 16V
(Resistor)		
R401a,b	06T00019L91	(Rd) 12K Ω 1/2W
R403a,b	06T00059L65	(Rd) 1K Ω 1/4W
R404a,b	06T00059L93	(Rd) 15K Ω 1/4W
R405a,b	06T00060L10	(Rd) 68K Ω 1/4W
R406a,b	06T00059L89	(Rd) 10K Ω 1/4W
R407a,b	06T00032L53	(Rf) 330 Ω 1/2W
R408a,b	06T00032L51	(Rf) 270 Ω 1/2W
R409a,b	06T00060L50	(Rd) 3.3M Ω 1/4W
R410a,b	06T00060L50	(Rd) 3.3M Ω 1/4W
R411a,b	06T00060L50	(Rd) 3.3M Ω 1/4W
R412a,b	06T00060L46	(Rd) 2.2M Ω 1/4W
R413a,b	06T00060L46	(Rd) 2.2M Ω 1/4W
R414a,b	06T00059L89	(Rd) 10K Ω 1/4W
R415a,b	06T00059L89	(Rd) 10K Ω 1/4W
R416a,b	06T00032L37	(Rd) 68 Ω 1/2W
R417	06T00059L87	(Rd) 8.2K Ω 1/4W
R418	06T00060L34	(Rd) 680K Ω 1/4W
R419	06T00060L34	(Rd) 680K Ω 1/4W
R420	06T00059L87	(Rd) 8.2K Ω 1/4W
R421a,b	06T00005L09	(Rd) 4.7 Ω 1W
R421a,b	06T00005L09	(Rd) 4.7 Ω 1W
R423a,b	06T00005L49	(Rd) 220 Ω 1W
R424a,b	06T00005L49	(Rd) 220 Ω 1W

Peak Hold PCB L/R Parts List

Symbol No.	Stock No.	Description
(Switch)		
S401a,b	40T64492F01	Push SUL211A
S402a,b	40T64492F01	Push SUL211A
(Resistor)		
R425a,b	06T00017L67	(Rd) 1.2K Ω 1/2W
R426a,b	06T00017L67	(Rd) 1.2K Ω 1/2W
R427a,b	06T00017L67	(Rd) 1.2K Ω 1/2W
R428a,b	06T00017L67	(Rd) 1.2K Ω 1/2W

LED PCB L/R Parts List

Symbol No.	Stock No.	Description
(LED)		
D406a,b	48T63906F01	EAY3432S O.Y
D407a,b	48T63906F01	EAY3432S O.Y

VR Control PCB L/R Prts List

Symbol No.	Stock No.	Description
(Relay)		
RY501a,b	80T00047L01	MZ-12W
(Variable Resistor)		
VR501a,b	18T64691F01	Rotary 50Sx2
(Capacitor)		
C501a,b	08T51403F09	(St) 0.27uF
C502	23T00029L21	(El) 22uF 16V
(Resistor)		
	06T00014L38	(Rd) 1M Ω 1/3W
	06T00014L43	(Rd) 120 Ω 1/3W

Fan Speed SW PCB Parts List

Symbol No.	Stock No.	Description
(Relay)		
RY601a,b	80T00047L01	MZ-12W
(Switch)		
S601	40T64491F01	Slide SSB04341
(Variable Resistor)		
RV601a,b	18C41732G18	2.2K
(Transistor)		
Q601a,b	48T64430F01	2SC2551
Q601a,b	48T64431F01	2SC2555
(Diode)		
D601a,b	48T53388F01	S1VB-20
(Diode, Zener)		
ZD601a,b	48T40150U27	HZ5C-3
(Resistor)		
R601a,b	06T00050L91	(Rd) 12K Ω 1/4W
R602a,b	30T64479F01	Jumper
R604a,b	06T00060L65	(Rd) 1K Ω 1/4W
R605a,b	06T00060L65	(Rd) 1K Ω 1/4W

Remarks

Resistor:

Rd Carbon
 Rm Frame Proof
 Rc Cement

Capacitor:

El Electrolytic
 Ce Ceramic
 My Mylar
 Mi Mica
 Pp Polypropylene
 St Styrol
 Ac AC

IC Handling Guide

IC, NJM082D

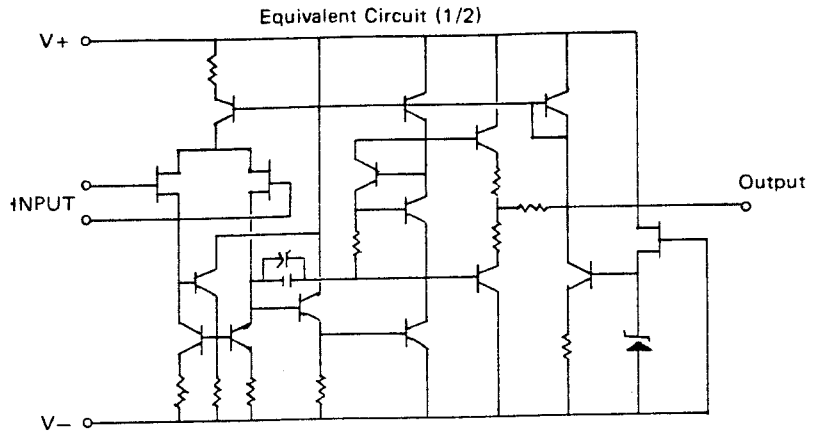
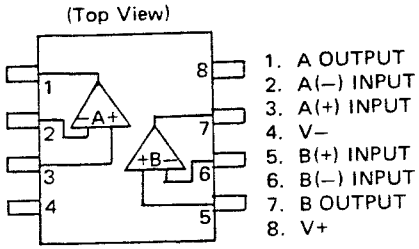

IC, TA7138P-2

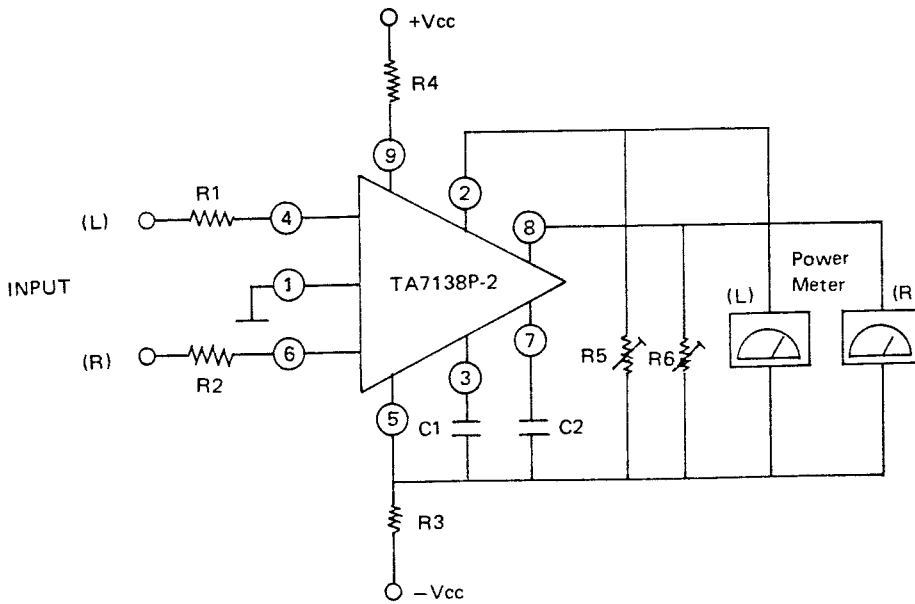

(Peak, Power Meter Drive)

Specifications

Power Output:	105W pure class "A" minimum continuous per channel, both channels driven into 8 ohms load, from 20 Hz to 20 kHz, with no more than 0.008% total harmonic distortion.
BTL(Duo-Alpha) Output:	400W into 8 ohms load, 20Hz – 20kHz, with no more than 0.015% total harmonic distortion.
Rated IM:	no more than 0.008% (8 ohms, 60Hz:7kHz = 4:1)
Input Sensitivity:	750mV
Frequency Response:	10Hz – 100kHz (within –0.5dB)
Input Impedance:	300k ohms (direct-in) 45k ohms (att-in)
S/N Ratio:	better than 120dB (IHF-A weighted, input short-circuited)
Additional Features:	Peak Meters with Peak-Hold, Terminals for Electrostatic Speaker, Signal-Off Switch, 3-Step Fan Speed Selector, BTL (Duo-Alpha) Selector, Subsonic Filter, Input Attenuators, etc.
Power Consumption:	540W
Dimensions:	460(W) x 437(D) x 210(H) mm
Weight:	Net 40kg, Gross 45.5kg

Specifications and appearance design subject to change without notice.

規 格

連続実効出力	105W + 105W (8Ω, 20~20kHz Aクラス両CH同時動作)
BTL接続実効出力	400W (8Ω, 20~20kHz)
全高調波歪率	0.008%以下 (8Ω, 両CH同時動作) 0.01% (4Ω両CH)
混交調歪率	0.008%以下 (8Ω, 60Hz : 7kHz = 4 : 1)
周波数特性	10~100kHz (–0.5dB)
入力感度	750mV
入力インピーダンス	DIRECT-IN 300kΩ ATT-IN 45kΩ
S/N比	(IHF-A補正) 120dB
付属装置	ピークホールド付ピークメーター(メーターOFF SW付) ELECTRO STATICスピーカ用端子 シグナル OFF SW 3段切換FAN SW ラインフェーズセンサ BTL接続SW サブソニックフィルターSW (15Hz) – 6dB/ect. 入力アッテネータ, ウォーム・アップ機構, プリヒート機構
保護回路	DCドリフト検出スピーカ保護回路 過電流検出アンプ保護回路 温度検出アンプ保護回路
電源電圧	AC100V (50Hz, 60Hz)
消費電力	540W (電気用品取締法の規定による)
外形寸法	460(幅) x 437(奥行) x 210(高)mm
重量	40kg NET, 45.5kg グロス

Schematic Diagram(1)

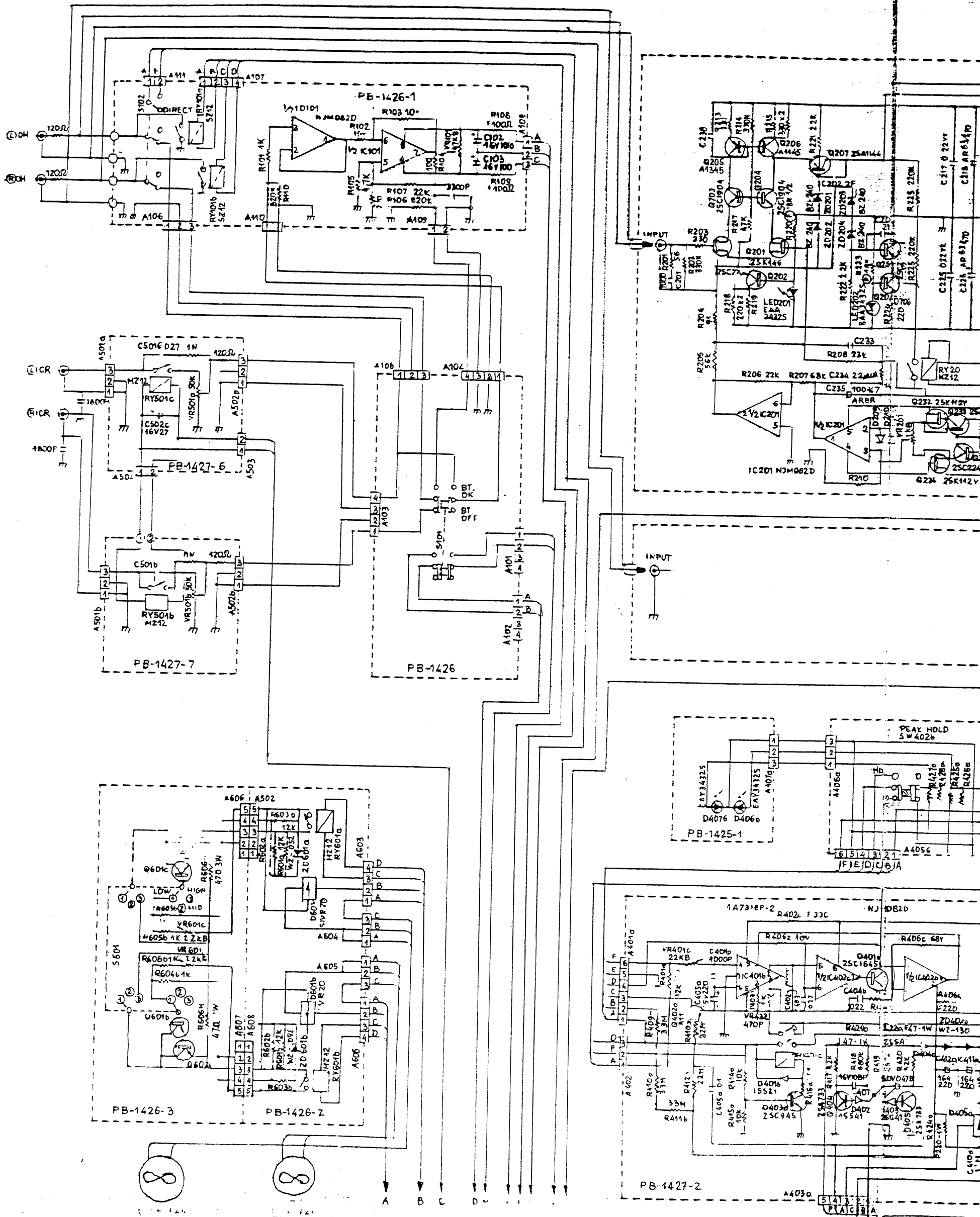

NOTES

- 1. UNLESS OTHERWISE SPECIFIED, ALL RESISTORS ARE IN OHMS, CAPS. ALL CAPACITORS ARE IN P.F.
- 2. TRANSISTORS AND DIODES MAY BE REPLACED WITH ANY TYPE HAVING EQUIVALENT CHARACTERISTICS.
- 3. DUE TO CONSTRUCTION IMPROVEMENT, THE RESISTOR VALUES MAY VARY FROM THE VALUES SHOWN.

Schematic Diagram(2)

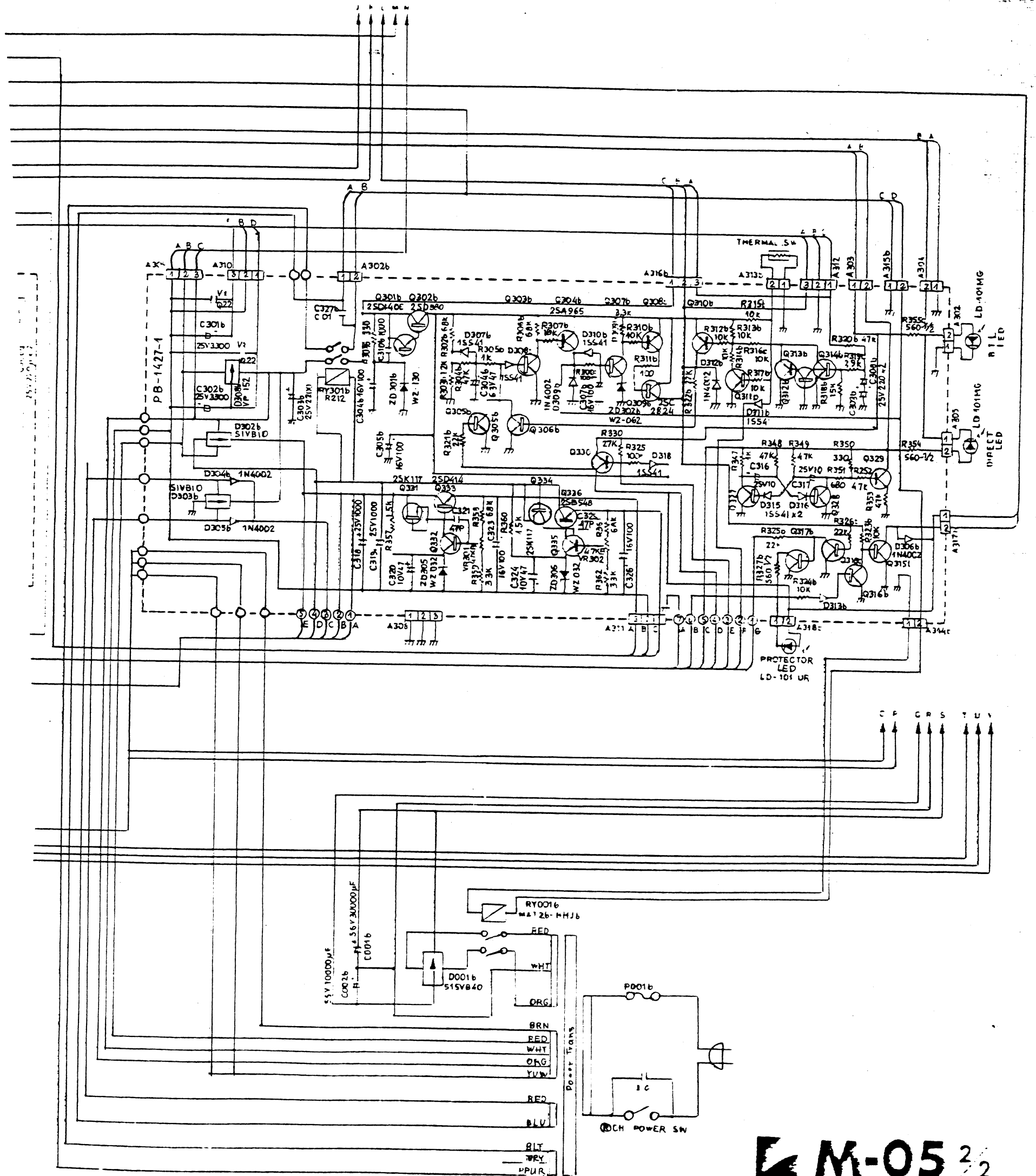

M-05 2/2